

# ESTRUTURA DO CASCO DOS NAVIOS METÁLICOS



**PEÇAS NÃO ESTRUTURAS E  
ACESSÓRIOS DO CASCO**

# Eixo propulsor

---

- São divididos em seções, ligadas entre si por:
  - Flanges aparafusados
  - Acoplamentos
- Eixo do hélice
  - Seção de ré do eixo propulsor, onde é ligado o hélice
- As demais seções são eixos intermediários que vão ligar ao eixo do motor

# Mancais

---

- Mancal axial ou de escora
- Mancais radiais ou de sustentação

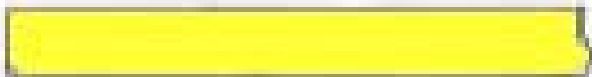

SAPATAS PLANAS

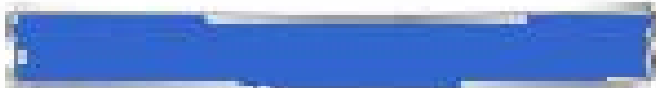

SAPATA CÔNICA



SAPATA EM DEGRAU

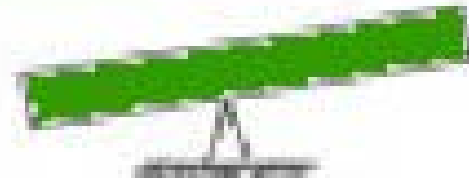

SAPATA PIVOTADA

# Esquema típico de uma linha de eixo

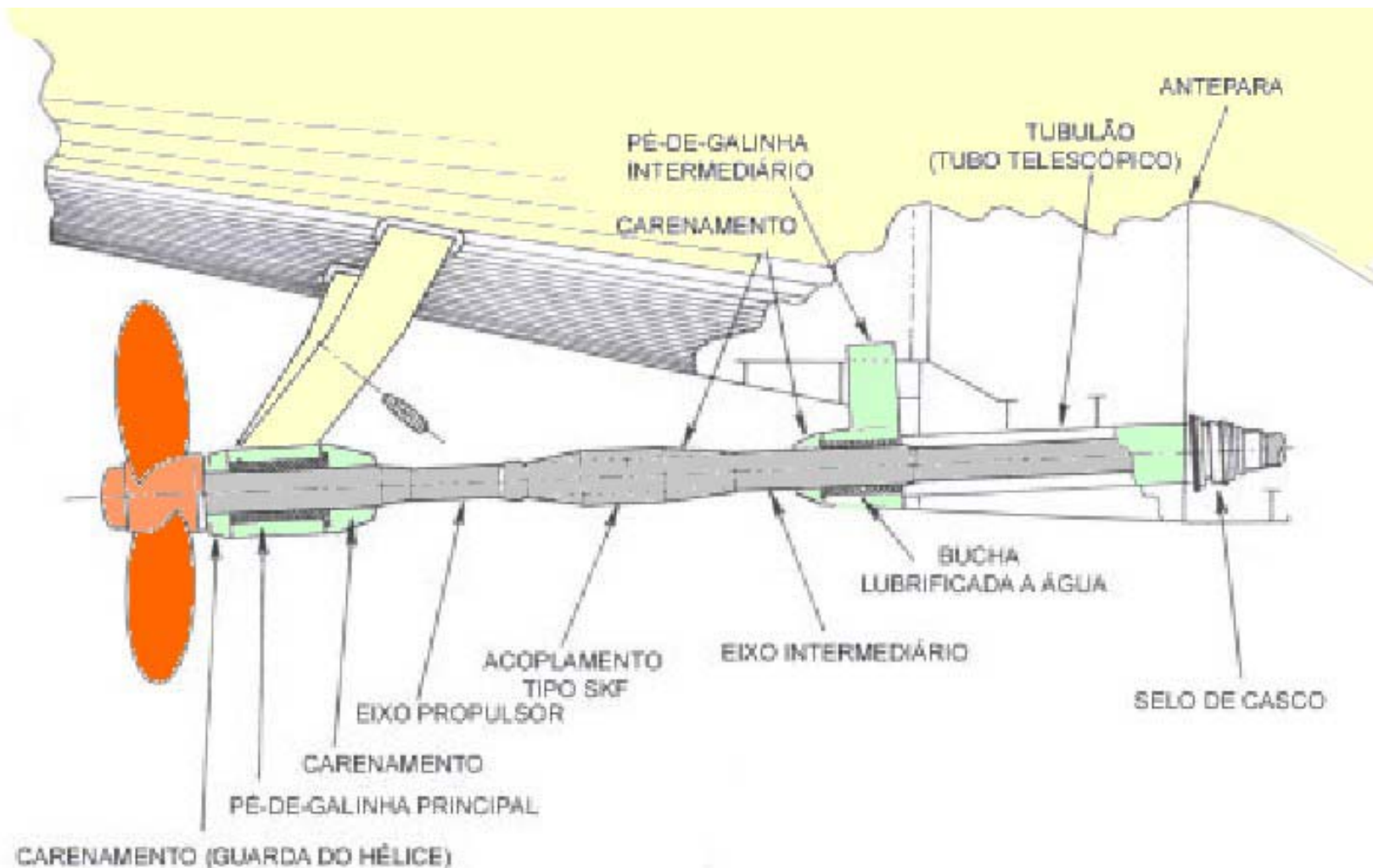

# Tubo telescópico do eixo

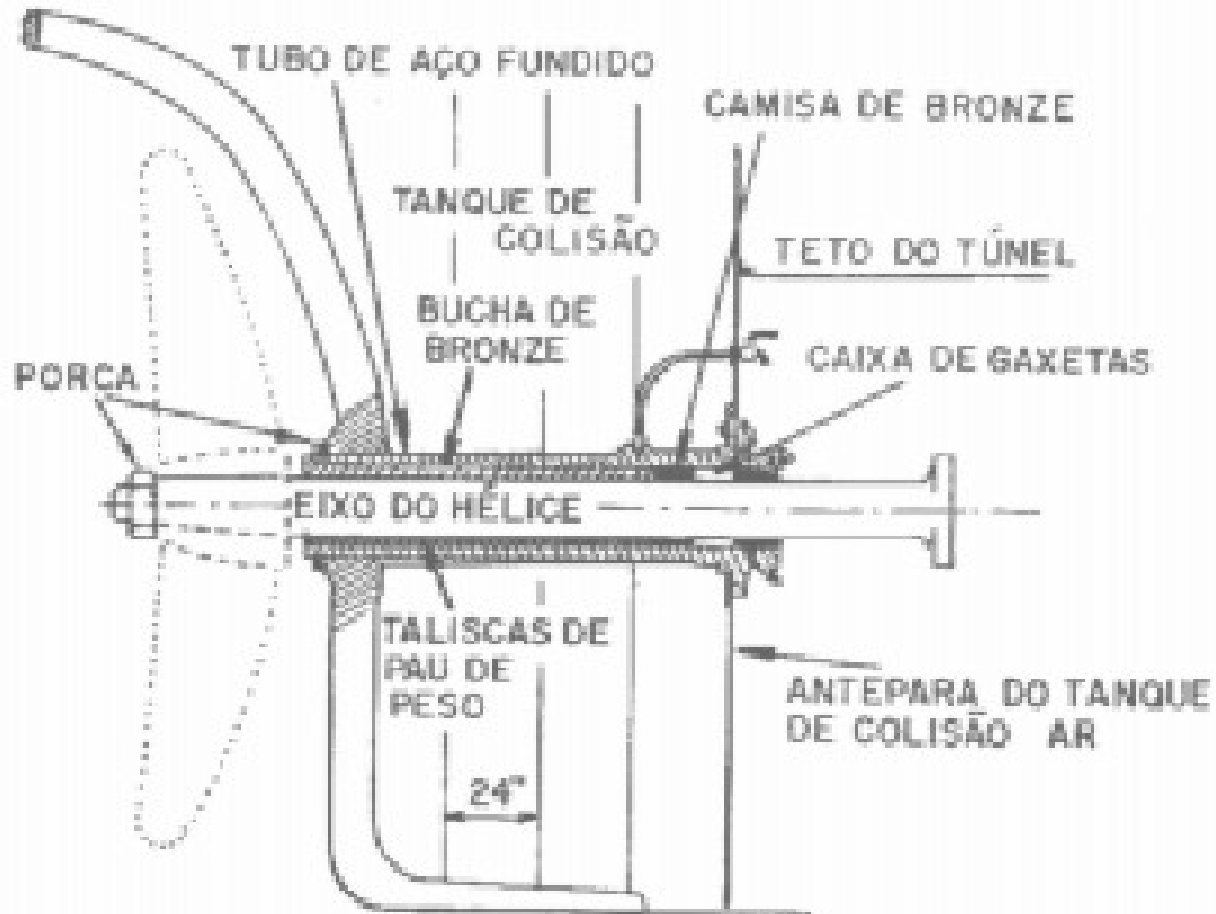

A - TUBO CURTO (1 MANCAL)

# Tubo telescópico do eixo

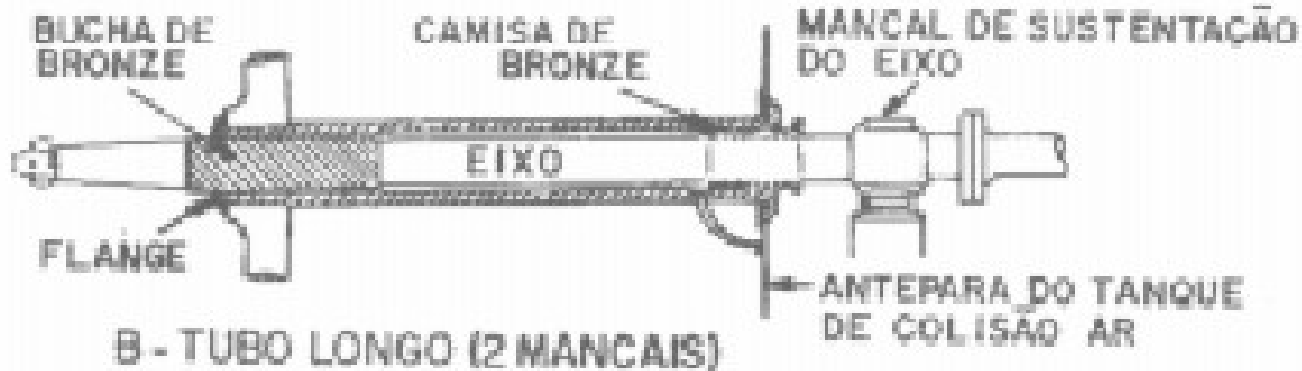

# Pés-de-galinha

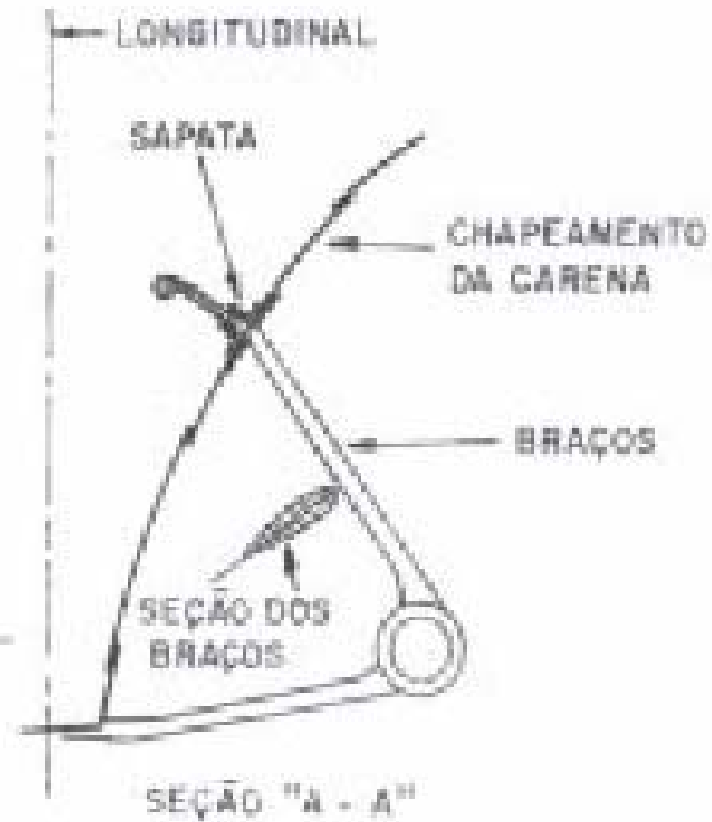
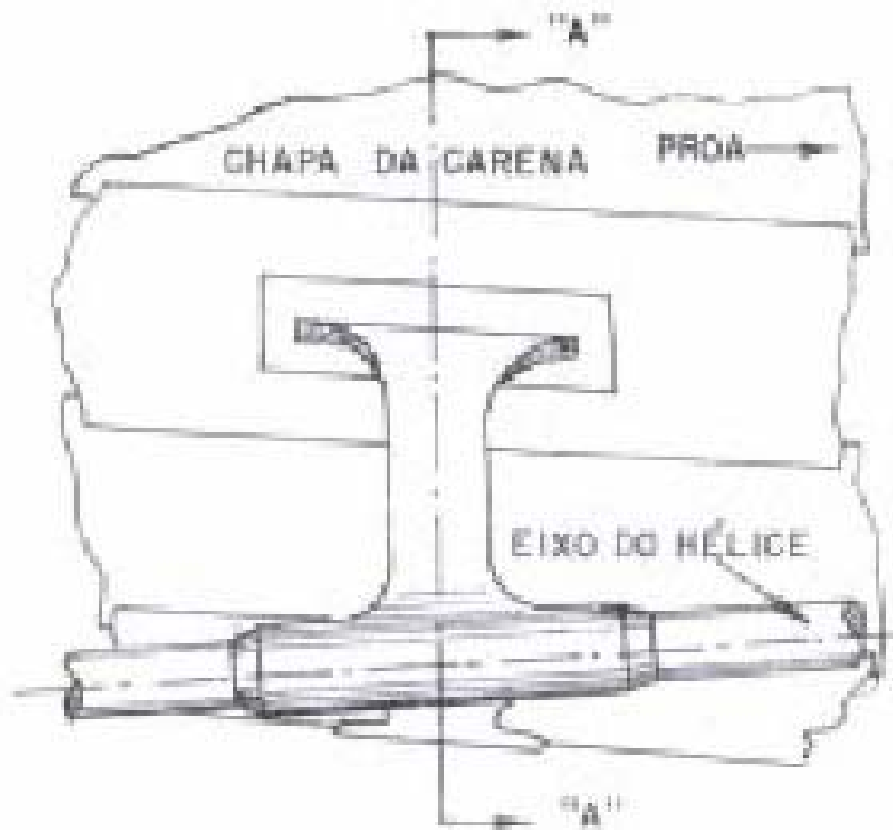

# Hélice

---

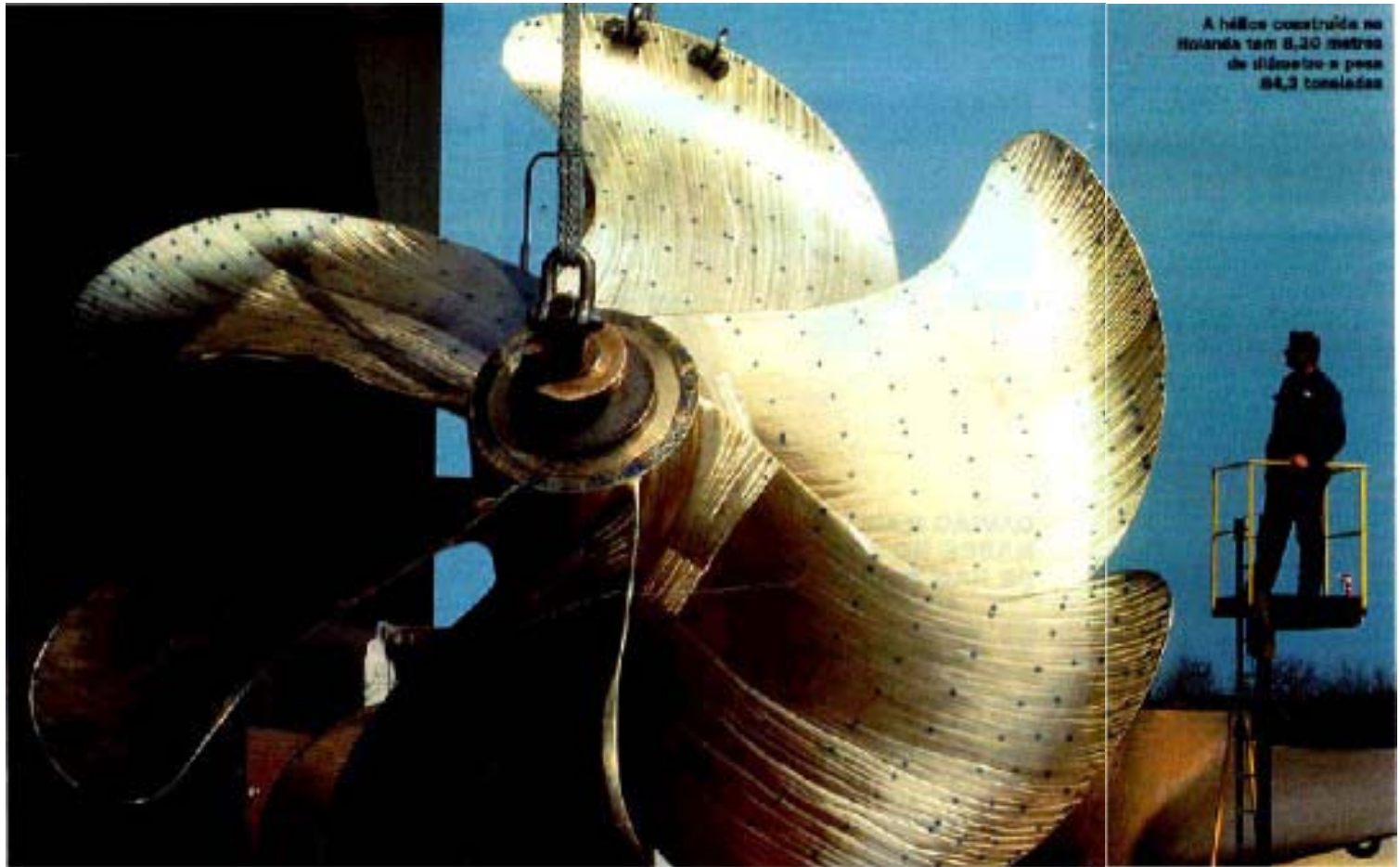



# Hélices

---

